



itl boulder
THE LIGHT CENTER OF THE INDUSTRY SINCE 1955

INDEPENDENT TESTING LABORATORIES, INC.
3386 LONGHORN ROAD, BOULDER, CO 80302 USA

PHONE: (303)442-1255 • FAX: (303)449-5274 • E-MAIL: itl@itlboulder.com • WEBSITE: www.itlboulder.com

ISOFOOTCANDLE LINES OF HORIZONTAL ILLUMINATION
Values based on 20 foot mounting height.

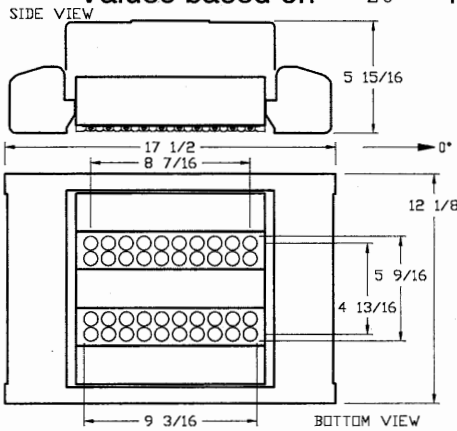

REPORT NUMBER: ITL64366
DATE: 03/10/10
PREPARED FOR: BETALED, A DIVISION OF RUUD LIGHTING
CATALOG NUMBER: PKG-EDG-5M-**-04-D-UL-WH-700 or BXPS0504D-UDW (700mA)
LUMINAIRE: EXTRUDED WHITE PAINTED METAL HOUSING WITH CAST WHITE PAINTED METAL END CAPS, FABRICATED WIRE CAGE MOUNTING ASSEMBLY, TWO EXTRUDED FINNED METAL HEAT SINKS, EACH HEAT SINK CONTAINS ONE CIRCUIT BOARD WITH 20 LEDS, CAST WHITE PAINTED METAL TRIM PLATE, ONE CLEAR NON-INTEGRAL PLASTIC LENS BELOW EACH LED. THREE FORMED WHITE PAINTED SOLID METAL TRIM PLATES.
LAMPS: FORTY WHITE LIGHT EMITTING DIODES (LEDS), VERTICAL BASE-UP POSITION.
TOTAL INPUT WATTS = 92.8 AT 240.0 VOLTS
LED DRIVER: BETA LED DPL-100BB A, WITH FIVE POSITION DIMMER CONTROL SWITCH.
NOTE: DATA SHOWN IS ABSOLUTE FOR THE SAMPLE PROVIDED AT RATED INPUT VOLTAGE (240VAC, 60Hz) TO THE LED DRIVER. CLIENT STATES LEDS HAVE BEEN SEASONED FOR A MINIMUM OF 100 HOURS. DIMMER CONTROL SWITCH IN POSITION "1" FOR THIS TEST.

TEST PROCEDURE: IESNA LM-79-08
TEST DISTANCE = 25.25 FEET

IES Cutoff Classification: Full Cutoff

Checked *M. Kloof*
Approved *R. Beattie*

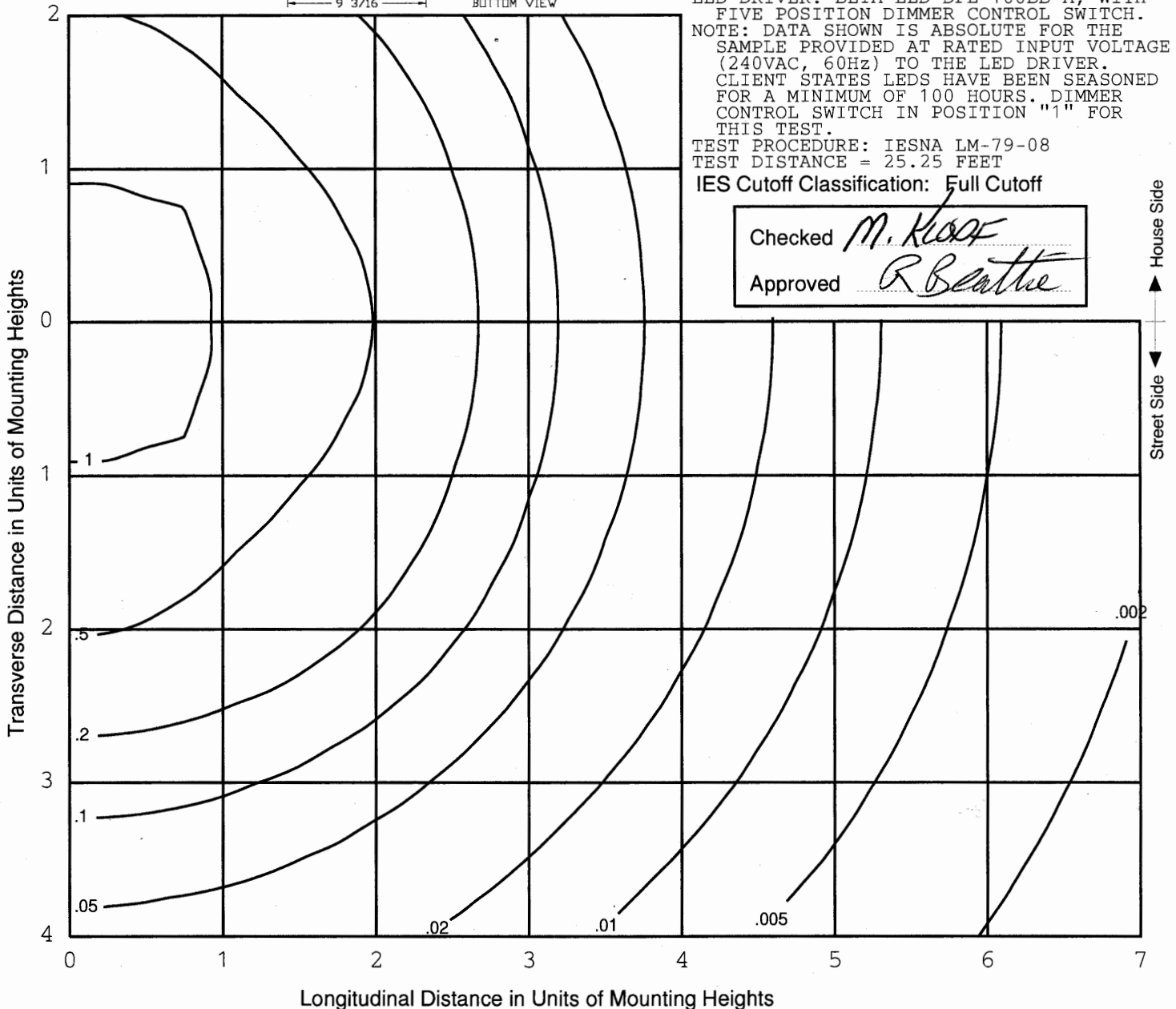

THIS REPORT IS BASED ON PUBLISHED INDUSTRY PROCEDURES. FIELD PERFORMANCE MAY DIFFER FROM LABORATORY PERFORMANCE.

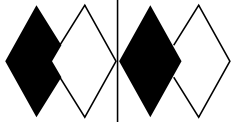

itl boulder
THE LIGHT CENTER OF THE INDUSTRY SINCE 1955

INDEPENDENT TESTING LABORATORIES, INC.
 3386 LONGHORN ROAD, BOULDER, CO 80302 USA

PHONE: (303)442-1255 • FAX: (303)449-5274 • E-MAIL: itl@itlboulder.com • WEBSITE: www.itlboulder.com

REPORT NUMBER: ITL64366
 DATE: 03/10/10
 PREPARED FOR: BETALED, A DIVISION OF RUUD LIGHTING
 CATALOG NUMBER: PKG-EDG-5M-**-04-D-UL-WH-700 or BXPS0504D-UDW (700mA)
 LUMINAIRE: EXTRUDED WHITE PAINTED METAL HOUSING WITH CAST WHITE PAINTED METAL END CAPS, FABRICATED WIRE CAGE MOUNTING ASSEMBLY, TWO EXTRUDED FINNED METAL HEAT SINKS, EACH HEAT SINK CONTAINS ONE CIRCUIT BOARD WITH 20 LEDS, CAST WHITE PAINTED METAL TRIM PLATE, ONE CLEAR NON-INTEGRAL PLASTIC LENS BELOW EACH LED. THREE FORMED WHITE PAINTED SOLID METAL TRIM PLATES.
 LAMPS: FORTY WHITE LIGHT EMITTING DIODES (LEDS), VERTICAL BASE-UP POSITION.
 TOTAL INPUT WATTS = 92.8 AT 240.0 VOLTS
 LED DRIVER: BETA LED DPL-100BB A, WITH FIVE POSITION DIMMER CONTROL SWITCH.
 NOTE: DATA SHOWN IS ABSOLUTE FOR THE SAMPLE PROVIDED AT RATED INPUT VOLTAGE (240VAC, 60Hz) TO THE LED DRIVER. CLIENT STATES LEDS HAVE BEEN SEASONED FOR A MINIMUM OF 100 HOURS. DIMMER CONTROL SWITCH IN POSITION "1" FOR THIS TEST.
 TEST PROCEDURE: IESNA LM-79-08
 TEST DISTANCE = 25.25 FEET

MAXIMUM PLANE AND MAXIMUM CONE PLOTS OF CANDELA

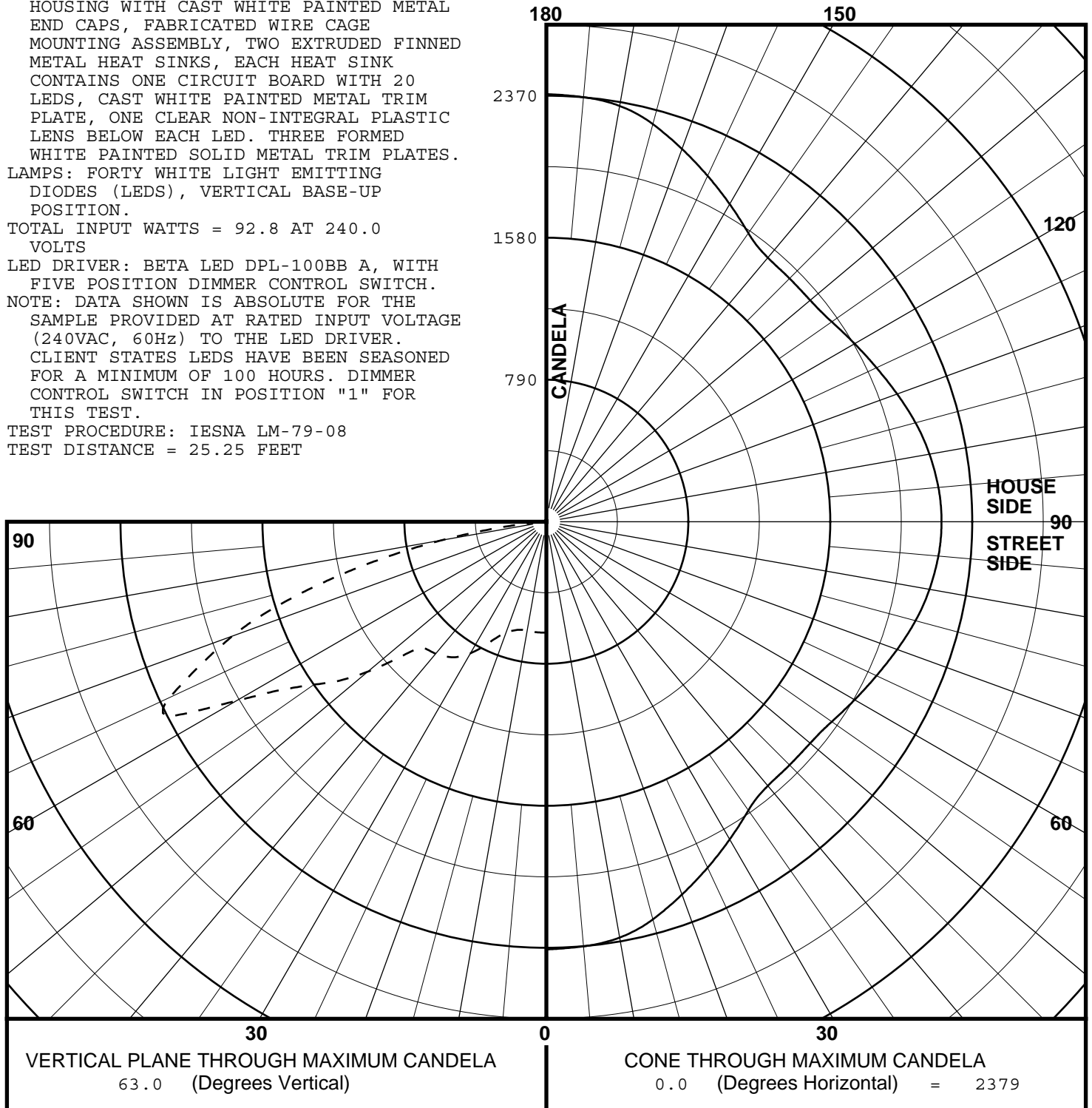

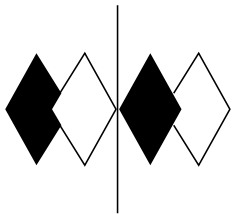

REPORT NUMBER: ITL64366
 DATE: 03/10/10
 PREPARED FOR: BETALED, A DIVISION OF RUUD LIGHTING

COEFFICIENTS OF UTILIZATION AND FLUX DISTRIBUTION

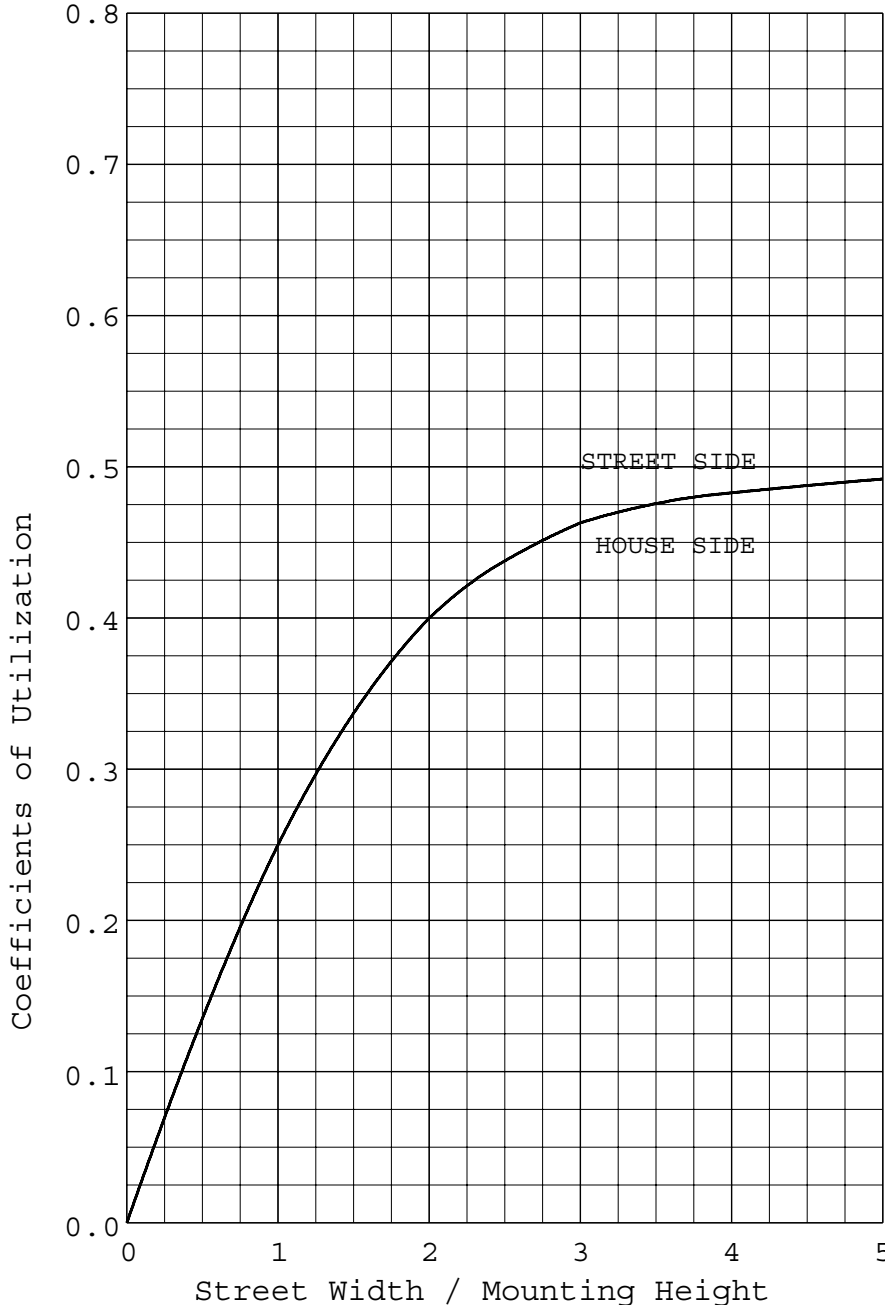

	LUMENS	PERCENT OF FIXTURE
DOWNWARD STREET SIDE	3486.	50.0
DOWNWARD HOUSE SIDE	3486.	50.0
DOWNWARD TOTAL	6971.	100.0
UPWARD STREET SIDE	0.	0.0
UPWARD HOUSE SIDE	0.	0.0
UPWARD TOTAL	0.	0.0
TOTAL FLUX	6971.	100.0
EFFICACY = 75.1 Lm/W		

ALL CANDELA AND LUMENS IN THIS REPORT ARE BASED ON ABSOLUTE PHOTOMETRY. THE COEFFICIENT OF UTILIZATION VALUES ARE BASED ON THE TOTAL ABSOLUTE LUMEN OUTPUT OF THIS LUMINAIRE SAMPLE.

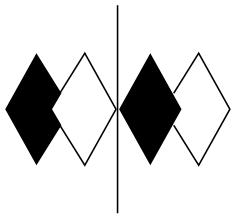

itl boulder
THE LIGHT CENTER OF THE INDUSTRY SINCE 1955

INDEPENDENT TESTING LABORATORIES, INC.
 3386 LONGHORN ROAD, BOULDER, CO 80302 USA

PHONE: (303)442-1255 • FAX: (303)449-5274 • E-MAIL: itl@itlboulder.com • WEBSITE: www.itlboulder.com

REPORT NUMBER: ITL64366
 DATE: 03/10/10
 PREPARED FOR: BETALED, A DIVISION OF RUUD LIGHTING

FLUX DISTRIBUTION BY SOLID ANGLE
 (PER IESNA TM-15-07, LUMINAIRE CLASSIFICATION
 SYSTEM FOR OUTDOOR LUMINAIRES)

	LUMENS	PERCENT OF FIXTURE
FORWARD LIGHT	3486.	50.0
FL (0- 30)		4.2
FM (30- 60)		20.6
FH (60- 80)		24.0
FVH(80- 90)		1.2
BACK LIGHT	3486.	50.0
BL (0- 30)		4.2
BM (30- 60)		20.6
BH (60- 80)		24.0
BVH(80- 90)		1.2
UPLIGHT	0.	0.0
UL (90-100)		0.0
UH (100-180)		0.0
TRAPPED LIGHT	0.	0.0
TOTAL FLUX	6971.	100.0

BACKLIGHT, UPLIGHT, AND GLARE (BUG) RATINGS
 (PER ADDENDUM A FOR IESNA TM-15-07)

BUG RATING: B3 U2 G1	FIRST DETERMINING SECONDARY SOLID ANGLE*	LUMENS
BACKLIGHT RATING: B3	BH	1671.5
UPLIGHT RATING : U2	FVH	84.7
GLARE RATING : G1	FVH	84.7

* NOTE: OTHER DETERMINING SOLID ANGLES MAY FALL INTO THIS SAME CATEGORY. ONLY THE FIRST DETERMINING ANGLES FROM THE TABLES A1-A3 IN THE ADDENDUM ARE SHOWN.

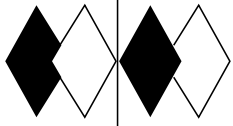

itl boulder

THE LIGHT CENTER OF THE INDUSTRY SINCE 1955

INDEPENDENT TESTING LABORATORIES, INC.
3386 LONGHORN ROAD, BOULDER, CO 80302 USA

PHONE: (303)442-1255 • FAX: (303)449-5274 • E-MAIL: itl@itlboulder.com • WEBSITE: www.itlboulder.com

REPORT NUMBER: ITL64366

DATE: 03/10/10

PREPARED FOR: BETALED, A DIVISION OF RUUD LIGHTING

CANDELA TABULATION

	LATERAL ANGLE										
	0.0	5.0	15.0	25.0	35.0	45.0	55.0	65.0	75.0	85.0	90.0
180.0	0.	0.	0.	0.	0.	0.	0.	0.	0.	0.	0.
175.0	0.	0.	0.	0.	0.	0.	0.	0.	0.	0.	0.
165.0	0.	0.	0.	0.	0.	0.	0.	0.	0.	0.	0.
155.0	0.	0.	0.	0.	0.	0.	0.	0.	0.	0.	0.
145.0	0.	0.	0.	0.	0.	0.	0.	0.	0.	0.	0.
135.0	0.	0.	0.	0.	0.	0.	0.	0.	0.	0.	0.
125.0	0.	0.	0.	0.	0.	0.	0.	0.	0.	0.	0.
115.0	0.	0.	0.	0.	0.	0.	0.	0.	0.	0.	0.
105.0	0.	0.	0.	0.	0.	0.	0.	0.	0.	0.	0.
95.0	0.	0.	0.	0.	0.	0.	0.	0.	0.	0.	0.
92.5	0.	0.	0.	0.	0.	0.	0.	0.	0.	0.	0.
90.0	0.	0.	0.	0.	0.	0.	0.	0.	0.	0.	0.
87.5	15.	15.	15.	16.	13.	13.	16.	18.	19.	20.	20.
85.0	85.	85.	83.	80.	55.	52.	78.	80.	84.	85.	85.
V 82.5	301.	300.	289.	274.	225.	210.	252.	260.	265.	269.	268.
E 80.0	592.	590.	579.	562.	514.	500.	525.	536.	539.	544.	543.
R 77.5	920.	917.	908.	897.	872.	858.	864.	864.	862.	859.	857.
T 75.0	1258.	1256.	1255.	1264.	1266.	1259.	1246.	1221.	1201.	1190.	1189.
I 72.5	1584.	1586.	1596.	1623.	1661.	1686.	1641.	1574.	1530.	1506.	1503.
C 70.0	1859.	1859.	1873.	1920.	1993.	2032.	1968.	1879.	1815.	1784.	1779.
A 67.5	2086.	2087.	2109.	2162.	2186.	2149.	2123.	2100.	2055.	2029.	2027.
L 65.0	2313.	2313.	2308.	2247.	2119.	2035.	2056.	2127.	2192.	2213.	2217.
63.0 <<	2379.	2371.	2290.	2123.	1960.	1914.	1939.	2027.	2127.	2190.	2199.
A 62.5	2338.	2328.	2215.	2038.	1908.	1866.	1885.	1967.	2067.	2132.	2141.
N 60.0	1992.	1992.	1904.	1818.	1768.	1749.	1757.	1804.	1874.	1924.	1931.
G 57.5	1736.	1735.	1717.	1691.	1668.	1663.	1668.	1695.	1728.	1748.	1750.
L 55.0	1580.	1580.	1578.	1576.	1579.	1586.	1585.	1597.	1612.	1615.	1615.
E 52.5	1452.	1452.	1459.	1472.	1492.	1505.	1500.	1497.	1496.	1491.	1491.
50.0	1298.	1301.	1325.	1363.	1400.	1417.	1406.	1388.	1365.	1348.	1346.
47.5	1125.	1129.	1154.	1206.	1262.	1287.	1272.	1234.	1194.	1172.	1167.
45.0	994.	998.	1027.	1073.	1116.	1137.	1122.	1089.	1056.	1039.	1035.
42.5	969.	970.	974.	989.	1013.	1028.	1016.	996.	986.	984.	984.
40.0	958.	959.	960.	958.	956.	957.	956.	959.	965.	966.	966.
37.5	942.	943.	941.	938.	935.	933.	933.	936.	941.	945.	945.
35.0	920.	919.	917.	912.	907.	904.	904.	909.	915.	919.	919.
30.0	845.	845.	843.	838.	832.	832.	833.	837.	839.	844.	844.
25.0	737.	737.	738.	744.	747.	750.	750.	746.	743.	743.	743.
20.0	656.	656.	660.	666.	670.	674.	671.	666.	661.	658.	657.
15.0	623.	623.	624.	627.	628.	630.	629.	626.	624.	623.	623.
10.0	614.	614.	615.	616.	617.	618.	617.	616.	615.	614.	614.
5.0	617.	617.	617.	617.	617.	618.	617.	617.	617.	616.	616.
0.0	617.	617.	617.	617.	617.	617.	617.	617.	617.	617.	617.

PLANE OF MAXIMUM CANDELA

CONE OF MAXIMUM CANDELA